

The Future: Sustainable Cement Production.

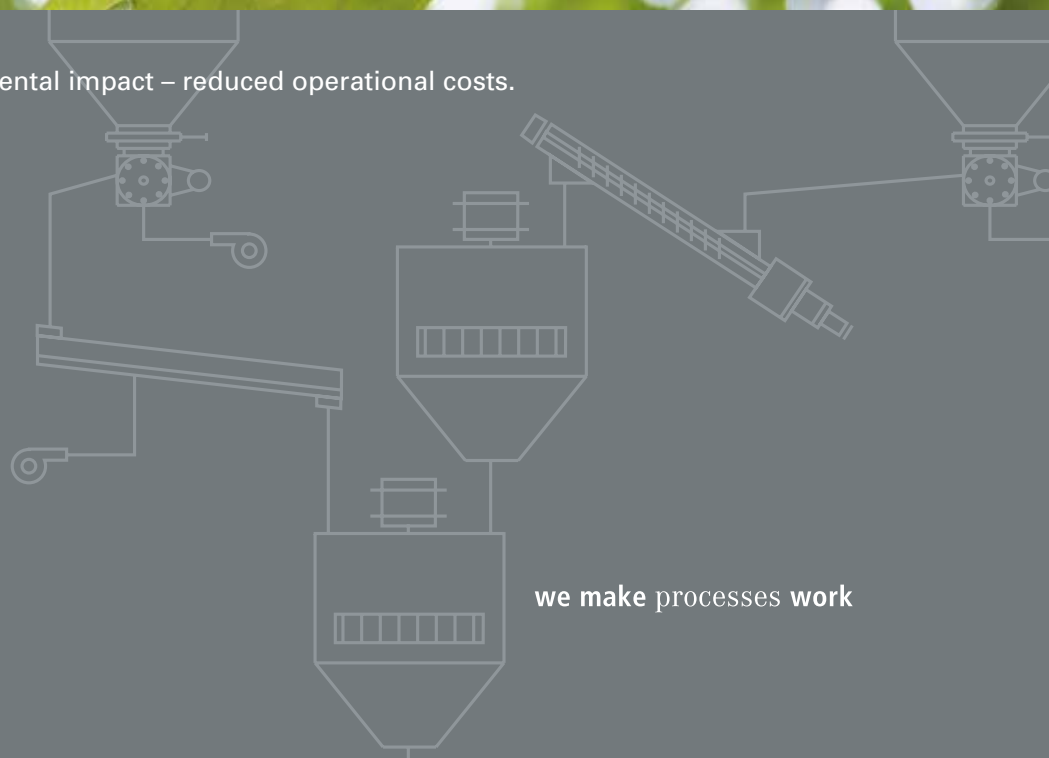

Benefits: reduced environmental impact – reduced operational costs.



we make processes work

Future-oriented Solution

Schenck Process Blending System

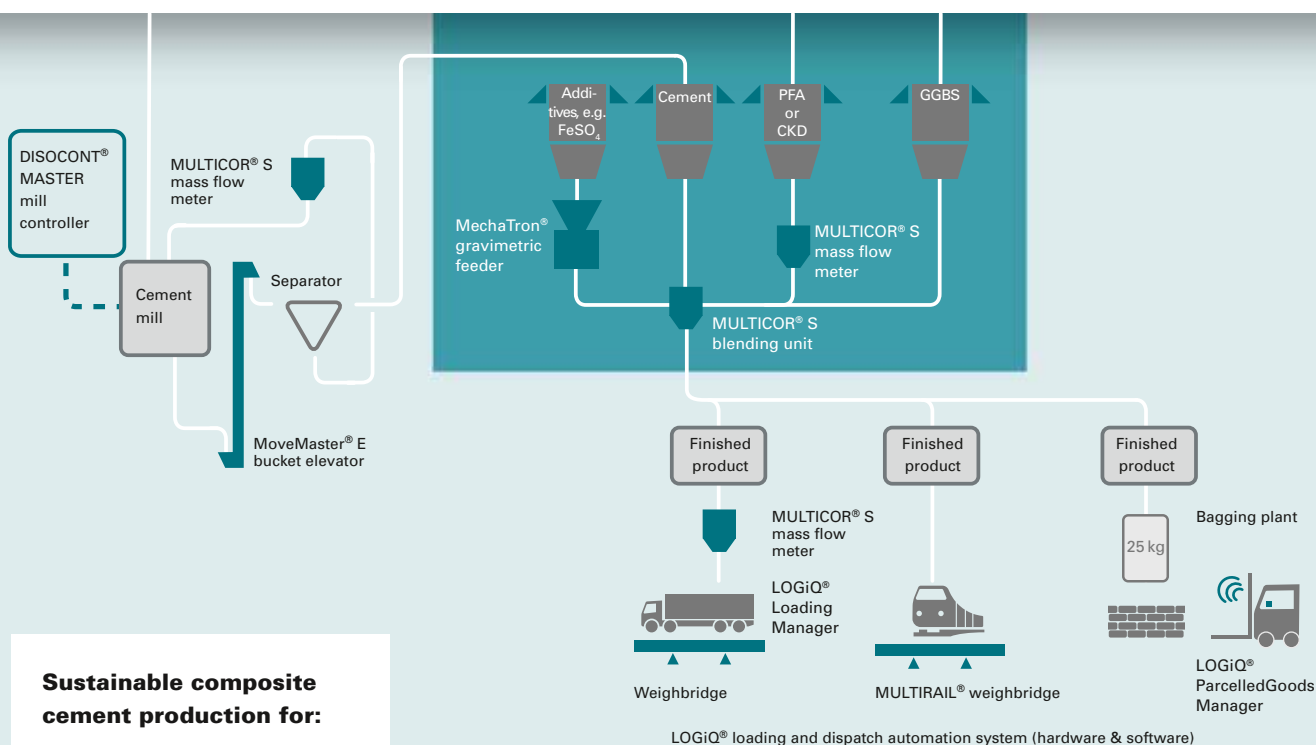

Sustainable composite cement production for:

- ❖ Blend to store at dense phase conveying rates of 120t/h
- ❖ Blend to vehicle loading at feed rates of 400t/h
- ❖ Blend to bagging lines at feed rates of 120t/h

Factory-made composite cements have been available for over 30 years, but until a legislative change intended to promote sustainable cement production, they have only been supplied to localised markets. Now, wide ranges of composite cements are available across Europe which incorporate limestone, fly ash or blast furnace slag as secondary constituents (additives). These factory-made composite cements are produced and supplied widely by the whole cement industry for use in either bulk delivery or packed in bags.

The significant benefits of our process solution lie in our unique capability of being able to harness the blending action of the MULTICOR® mass flow meter to homogeneously and accurately blend the cement master material, e.g. Ordinary Portland Cement (OPC), with secondary constituents on a sustainable basis.

By application of our process know-how, the MULTICOR® blending system differs from the typically employed method of batch blending and storage. It allows the cement producer to secure the advantages of sustainable continuous blending.

Future-oriented Solution for Manufacturing



Saving potential for new blending plants
(retrofit solutions also available)

Raw material intake & storage	3.5 m EUR	3.5 m EUR
	+	+
Blending	2.4 m EUR	1.1 m EUR
	+	
Storage	1.0 m EUR	Not required
	=	=
Total capital equipment cost	6.9 m EUR	4.6 m EUR

Normal cement production processes are based on producing and storing goods in the expectation of them being consumed, and in manufacturing terms, this is usually called the push principle.

This principle can be an inefficient use of both resource and capital, resulting in increased stock levels and the tying up of cash.

Therefore, the Schenck Process MULTICOR® blending system facilitates the manufacturing pull principle by only producing goods when they are ordered. There is no need for the cement manufacturer to store blended products in the expectation of consumption. Thus stock levels can be reduced and cash freed to be used more efficiently elsewhere in the business.

Schenck Process and the cement manufacturer: together we make processes work

Standard plant Schenck Process plant

The term composite cement means any cement type that conforms to BS EN 197-1 [1] (or BS EN 197-4 [2]) other than CEM I.

They comprise Portland cement combined with one or more additional inorganic constituents, plus an optimised amount of set-regulator (gypsum).

The main factory-made composite cements that cement manufacturers currently produce are:

Types (mainly relevant for Europe)	Designation	% additive
Cem II Portland limestone cement	CEM II/A-L + II/A-LL	6 to 20%
Cem II Portland fly ash cement	CEM II/A-V	6 to 20%
Cem II Portland fly ash cement	CEM II/B-V	20 to 35%
Cem III Low early strength blast furnace cement	CEM III/A	36 to 65%

Future Standards of Composite Cements



Schenck Process understands the drivers for continuous production of composite cements on a sustainable basis. Through our industry experience, continuous development of market-leading technology and application of our process knowledge we can add significant value to your business.

Drivers for continuous production of composite cements on a sustainable basis

Change in legislation leading to the wider use of secondary constituents in OPC

Expands the localised manufacturing practise

Facilitates the proliferation of the pull manufacturing principle

Contributes to the reduction of environmental pollutants

Application of Schenck Process process know-how

Cement manufacturers' benefits

Assists in meeting CO₂ reduction targets

Facilitates the manufacturing pull principle via sustainable blending

Lower capital equipment investment costs – no need to store blended material

Retrofitting solutions in existing plants

Co-operation with a global solution provider who understands your market and production needs

Future-oriented Demands for Ecological Building Materials



Cement produced with 30% additives uses 230 kg or 27% less CO₂ than conventional cement without additives.

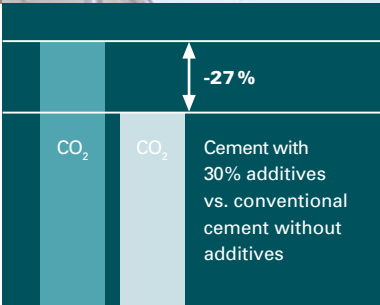

The integration of sustainability into all operations now sets the international cement industry's agenda. The implications for cements are already clear. Their energy and carbon footprint must be reduced over time without jeopardising product performance. The increasing availability of blended cements for use in concrete, mortar and grout plus the continued production of niche masonry cements for use only in mortar will help the industry to meet its social and environmental obligations and achieve necessary economic objectives.

A commitment to the environment runs throughout many of the process solutions offered by the Schenck Process Group, e.g. systems designed to optimise the use of alternative fuels (energy from waste), coal-washing plants (to reduce airborne pollution) or environmental controls in power plants (to reduce NO_x and SO_x emissions). And we are proud of the contribution that we make.

Furthermore, enabling cement producers to reduce their investment levels in capital equipment and operating costs utilising the MULTICOR® blending system to homogeneously and accurately blend cement with a secondary constituent contributes to users being able to reduce their environmental pollutants, e.g. CO₂ emissions.

Meeting Future Requirements The MULTICOR® Mass Flow Meter

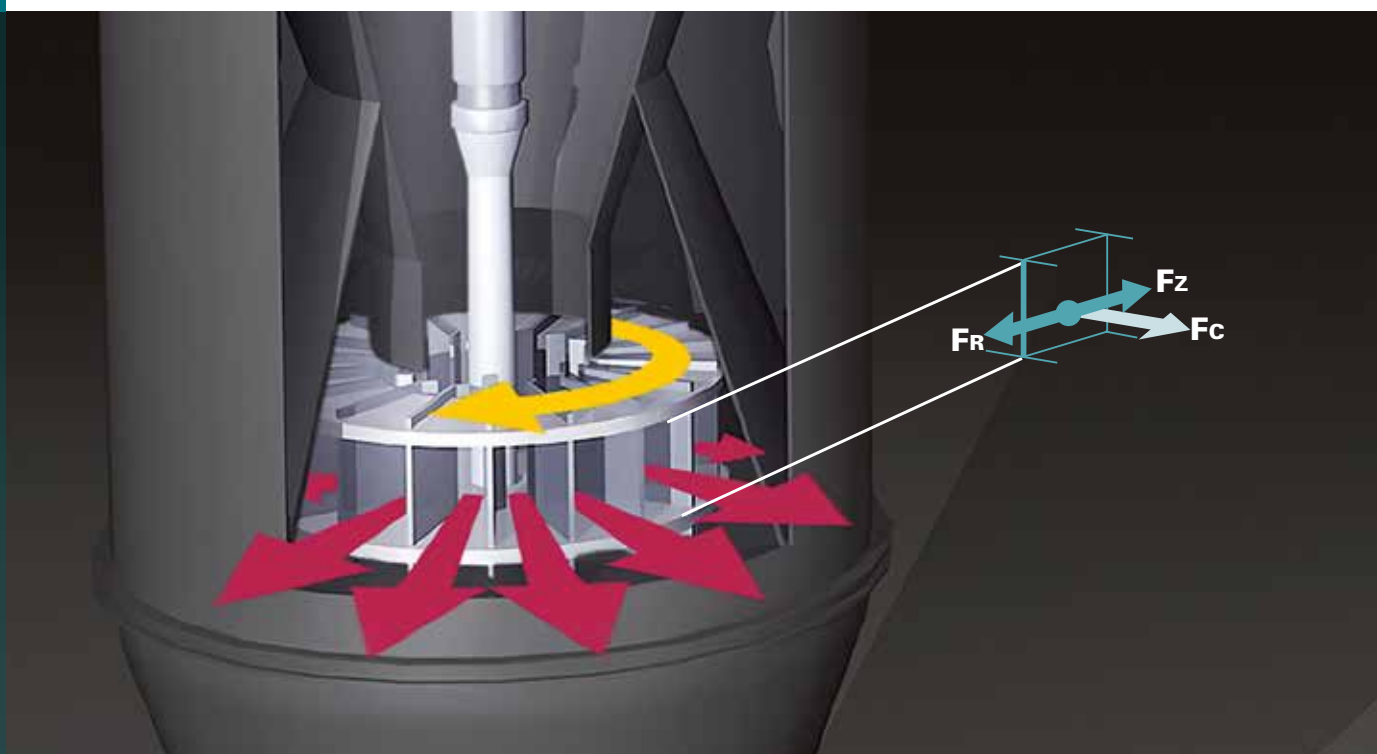

Continuous production of composite cements on a sustainable basis

A key benefit of the Schenck Process solution is its ability to instantly change the percentage of additives (secondary constituents).

This allows the production of the complete range of products on a sustainable basis, negating the need for storage of each of the different grades produced.

What's behind this revolutionary process innovation?

Our unique solution is the innovative application of our expertise in bulk material handling and process technology combined with market leading process equipment, i.e. the MULTICOR® mass flow meter. With over 2,000 MULTICOR® systems in the market, developing its use for the production of composite cement on a continuous basis is an application extension of this very successful long-standing product.

MULTICOR® operating principle:

- ◆ Continuous fixed-speed rotating measuring wheel contained within a dust-tight body.
- ◆ Bulk material enters the centre of the measuring wheel and is centrifugally accelerated outwards.
- ◆ This action creates a torque, which corresponds directly to the feed rate.
- ◆ The torque is measured with a measuring module (Schenck Process load cell).
- ◆ Data is communicated from the measuring module to the Schenck Process DISOCONT® control system.

The MULTICOR® blending system's operating principle and advantages

- ❖ Two MULTICOR® mass flow meters are controlled synchronously using a Schenck Process DISOCONT® control system (one MULTICOR® handling OPC and the other an additive).
- ❖ Bulk material is conveyed to the MULTICOR® systems using pre-feed devices.
- ❖ The MULTICOR® for the additive meters the flow of material into the downstream MULTICOR® for blending with the OPC.
- ❖ When optimally configured, the MULTICOR® blending system accurately and homogeneously mixes the OPC and additives.
- ❖ High accuracy and constancy are well-known benefits of the MULTICOR® system. The centrifugal action of the MULTICOR® system measuring rotor facilitates the homogeneous mixing of materials as they are fed through the machine (in a dust-tight enclosure).
- ❖ The resultant quantity and quality of the finished product is significantly enhanced without the need to blend and store the material prior to consumption.
- ❖ Thus, a truly continuous weighing and mixing plant has been developed.

The MULTICOR® Blending System



MULTICOR® S

MULTICOR® R

Throughput (vol.)

40 – 160 m³/h

40 – 800 m³/h

Accuracy (± %)

From ± 0.5% upwards

From ± 0.5% upwards

Setting range

1:10

1:10

Operating pressure

– 10 mbar to + 30 mbar

– 85 mbar to + 25 mbar

ATEX (explosion) rating

II 1/2/3 GD

II 3 GD

Schenck Process' success in the market:

Over 2,000 MULTICOR® units in operation worldwide

**Schenck Process:
International Business
Segment (IBS) Heavy**

**Reliability and economy
in the harshest industrial
environments**

IBS Heavy products and applications provide control of continuous material flows, continuous weighing and feeding systems for coarse bulk materials, powders, dusts, primary and alternative fuels, screening, vibratory and volumetric mechanical feeding systems, pneumatic conveying systems as well as heavy load acquisition and discontinuous weighing solutions.

Harsher environmental conditions require more resilient technical solutions. This particularly applies to industries such as cement and building materials, steel-making, non-ferrous metals and foundries. Schenck Process offers these industries a wide range of reliable systems and sound application know-how.

Process Steps Covered by the Schenck Process Group

Raw Material Handling

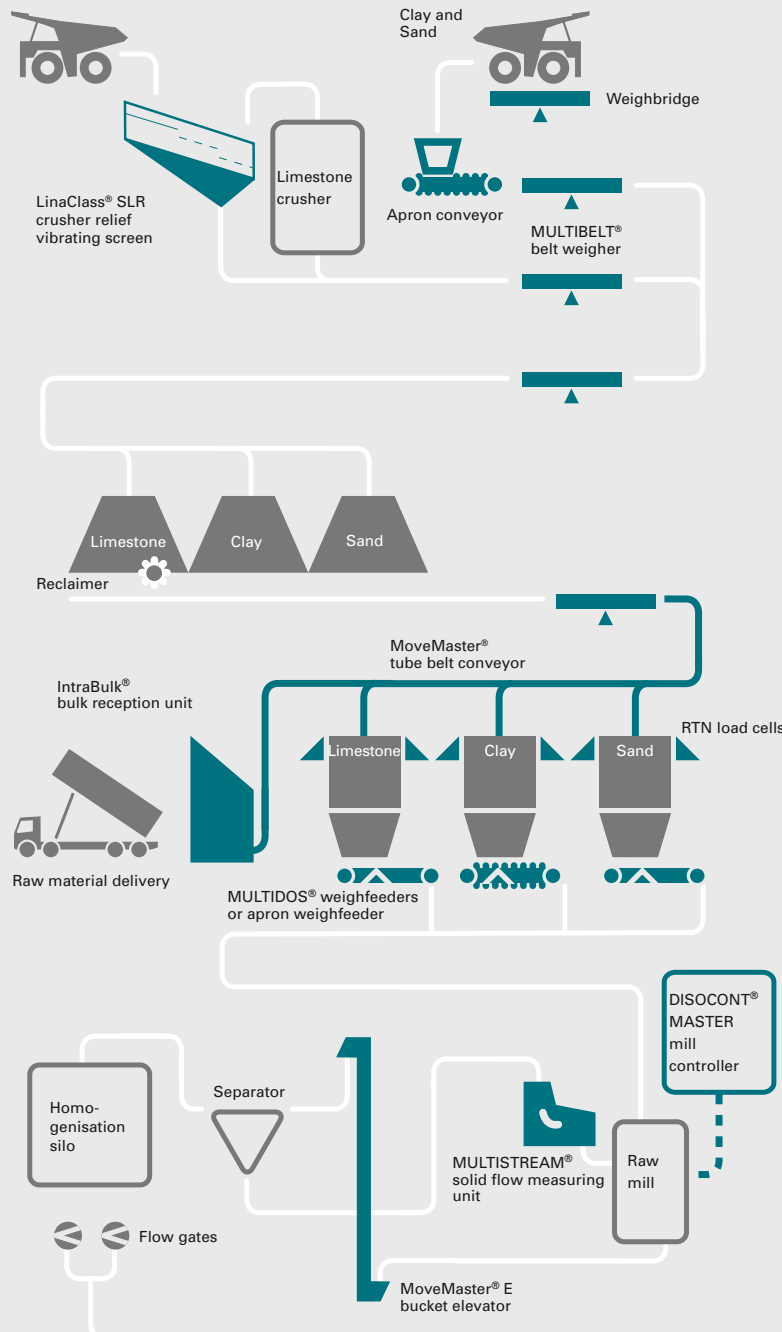

Calciner & Kiln Feeding

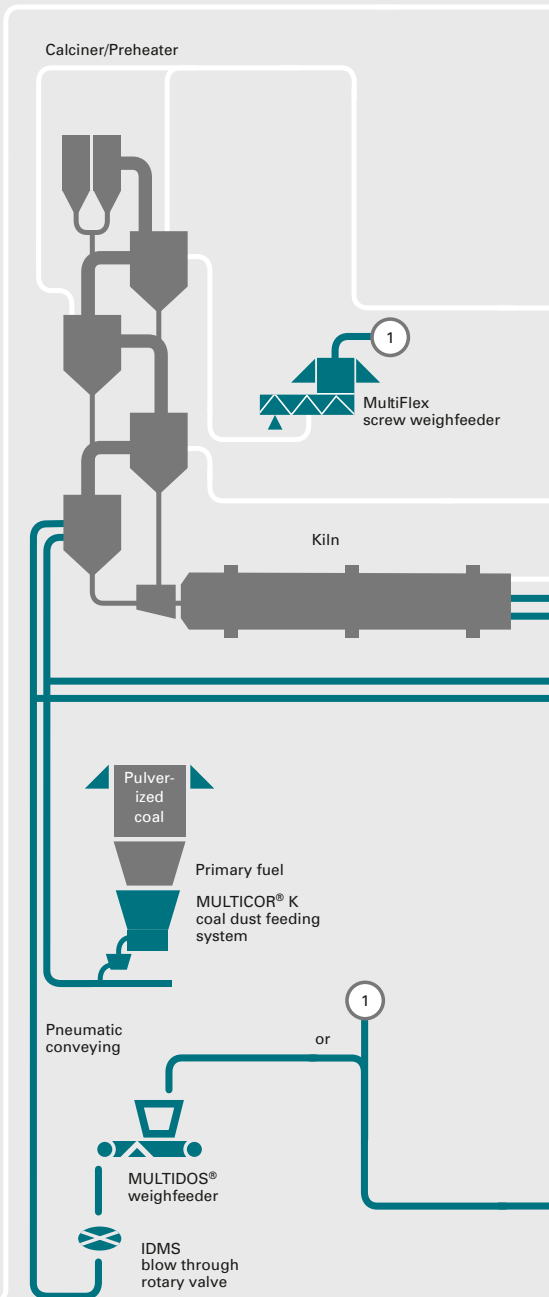

Bulk material handling

Our expertise in process automation includes bulk material handling applications such as loading, discharging, conveying and material distribution and includes a range of solutions for the handling of bulk solids and alternative fuels.

Vibrating and screening technology

Our vibratory equipment masters even the most difficult bulk materials. From large lumps to the finest particles, wet or dry and irrespective of whether ores, scrap, lime dust or hot sinters up to 1,000°C are used. Our range of products, applications and services comprises the planning, design and construction of complete plant sections including reliable controls and interfacing with higher-level data systems. These products and services are durable with a wide range of possible applications. They are practically indestructible even in the harshest industrial environments.

Weighing and feeding technology

Continuous weighing and feeding systems from Schenck Process are widely used in many industries, e.g. to feed coal dust efficiently into a rotary kiln during cement production. Our discontinuous scales can calculate the precise addition of alloying agents in electric steelworks or the exact weight of a steel ladle weighing several tonnes in a continuous casting plant.

Our wide range of products, applications and services includes the installation of weighfeeders, e.g. upstream of the blast furnaces for precise weighing of constituents to specific formulae as well as engineering and turnkey delivery of complete systems designed to convey and feed alternative fuels.

Fulfilling process-critical applications throughout the following industries:

Cement
Gypsum
Sand & Gravel
Steel
Non-ferrous Metals

Legend:
Process steps covered by the Schenck Process Group

Cement Storage and Dispatch

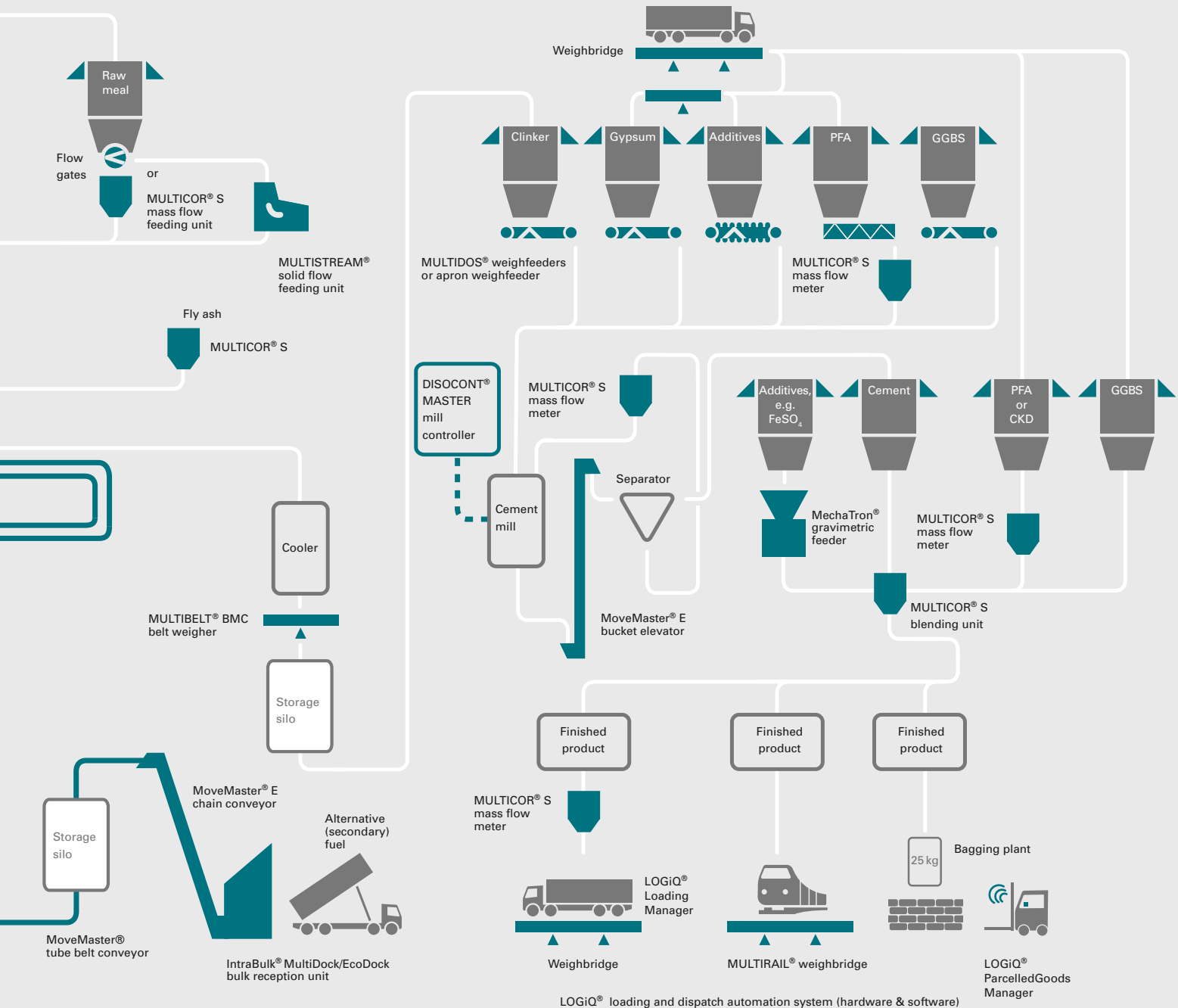

LOGiQ® loading and dispatch automation system (hardware & software)

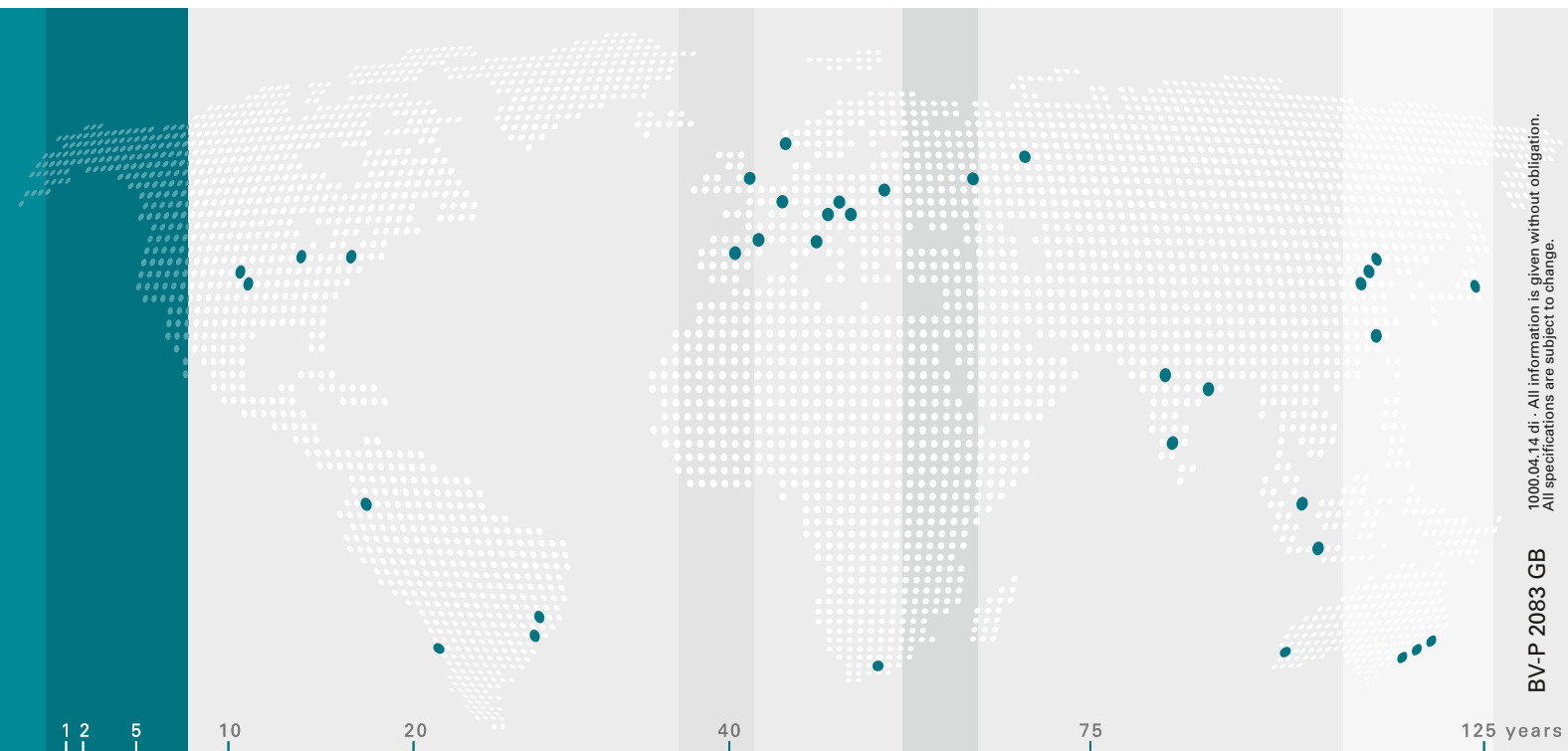

1000.04.14 di - All information is given without obligation.
All specifications are subject to change.

BV-P 2083 GB

The Schenck Process Group is a global leader in
weighing and feeding technology /// screening and separation systems for bulk materials /// dust collection and
air filtration technology /// pneumatic and mechanical conveying solutions /// automation and diagnostic technology

Schenck Process GmbH
Pallaswiesenstr. 100
64293 Darmstadt, Germany
T +49 61 51-15 31 29 53
F +49 61 51-15 31 38 46
heavy@schenckprocess.com
www.schenckprocess.com

we make processes work